

# Calliert

## Jeep Wrangler Running Board - 2 Door

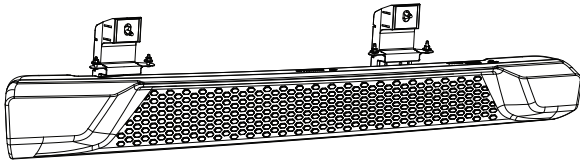

**A** LH

8\*20 Hexagon Screw  
M10 Gasket

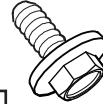

**C** 4x

M6 Flange screw



**D** 8x

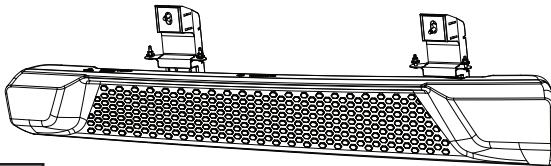

**B** RH

6\*20 Hexagon socket head screw  
M6 Gasket  
M8 Gasket

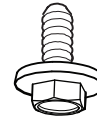

**E** 16x

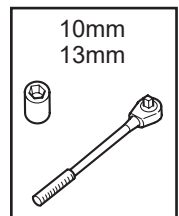
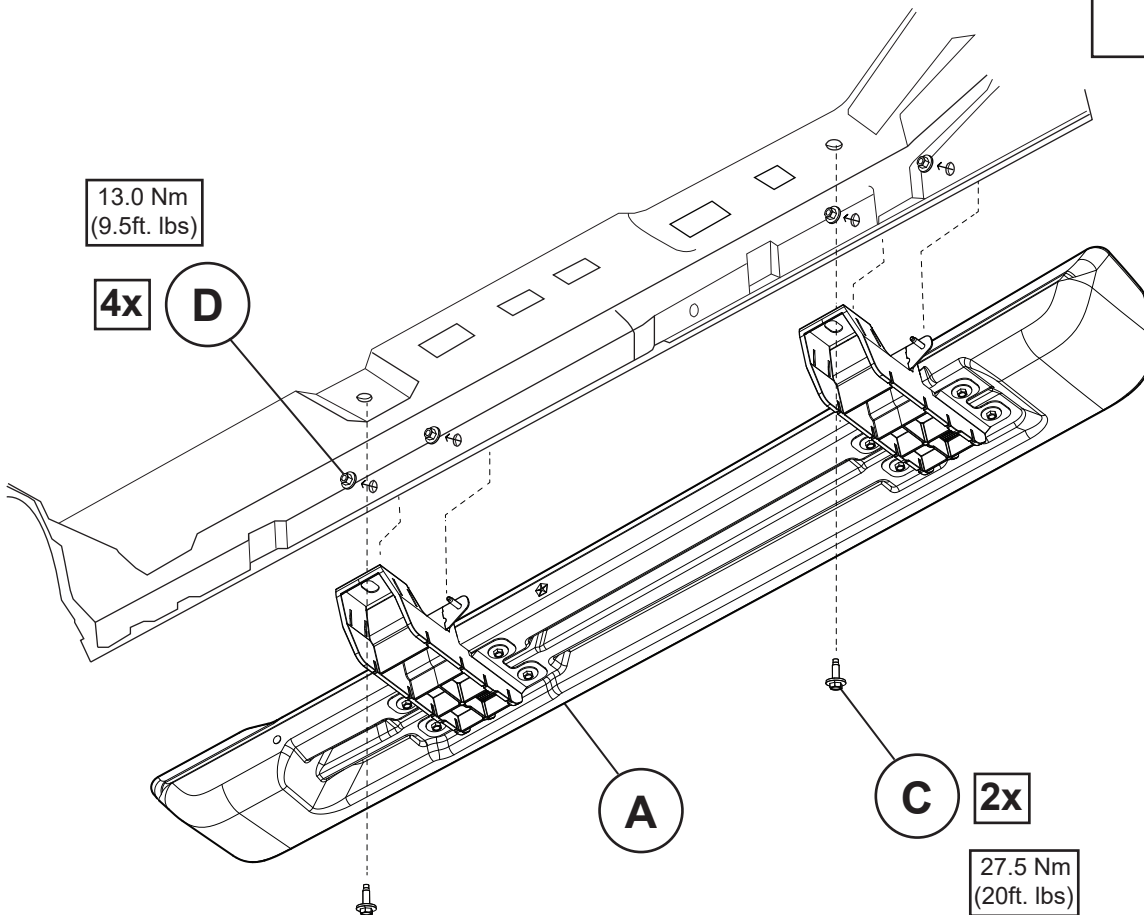
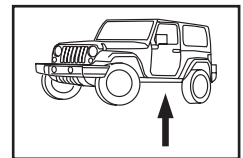

Note: Repeat for other side